

Personal Audio System

Operating Instructions

ZS-X3CP

Warning

To prevent fire or shock hazard, do not expose the player to rain or moisture.

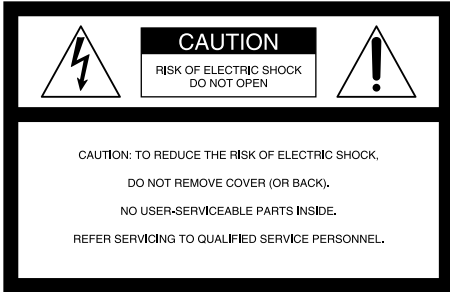

This symbol is intended to alert the user to the presence of uninsulated “dangerous voltage” within the product's enclosure that may be of sufficient magnitude to constitute a risk of electric shock to persons.



This symbol is intended to alert the user to the presence of important operating and maintenance (servicing) instructions in the literature accompanying the appliance.

CAUTION

The use of optical instruments with this product will increase eye hazard.

WARNING

Do not install the appliance in a confined space, such as a bookcase or built-in cabinet.

To prevent fire or shock hazard, do not place objects filled with liquids, such as vases, on the appliance.

For customers in Canada

To prevent electric shock, match wide blade of plug to wide slot, fully insert.

Information

For customers in the United States

This equipment has been tested and found to comply with the limits for a Class B digital device, pursuant to Part 15 of the FCC Rules. These limits are designed to provide reasonable protection against harmful interference in a residential installation. This equipment generates, uses and can radiate radio frequency energy and, if not installed and used in accordance with the instructions, may cause harmful interference to radio communications. However, there is no guarantee that interference will not occur in a particular installation. If this equipment does cause harmful interference to radio or television reception, which can be determined by turning the equipment off and on, the user is encouraged to try to correct the interference by one or more of the following measures:

- Reorient or relocate the receiving antenna.
- Increase the separation between the equipment and receiver.
- Connect the equipment into an outlet on a circuit different from that to which the receiver is connected.
- Consult the dealer or an experienced radio/TV technician for help.

You are cautioned that any changes or modifications not expressly approved in this manual could void your authority to operate this equipment.

Owner's Record

The model number is located at the bottom and the serial number is located in the battery compartment.

Record the serial number in the space provided below. Refer to these numbers whenever you call upon your Sony dealer regarding this product.

Model No. ZS-X3CP

Serial No. _____

Table of contents

Basic Operations

Playing an audio CD or MP3 files	4
Listening to the radio	8

The CD Player

Using the display	10
Locating a specific point in a track	11
Playing tracks repeatedly (Repeat Play)	11
Playing tracks in random order (Shuffle Play)	12
Creating your own program (Program Play)	13
Preventing sound from skipping (ESP)	14

The Radio

Presetting radio stations	15
Playing preset radio stations	16

The Audio Emphasis

Selecting the audio emphasis (MEGA BASS)	17
---	----

Setting Up

Choosing the power sources	18
Enjoying various pattern options on the display	19

Additional Information

Precautions	20
Troubleshooting	21
Maintenance	23
Specifications	24
About "MP3"	25
Index	26

Playing an audio CD or MP3 files

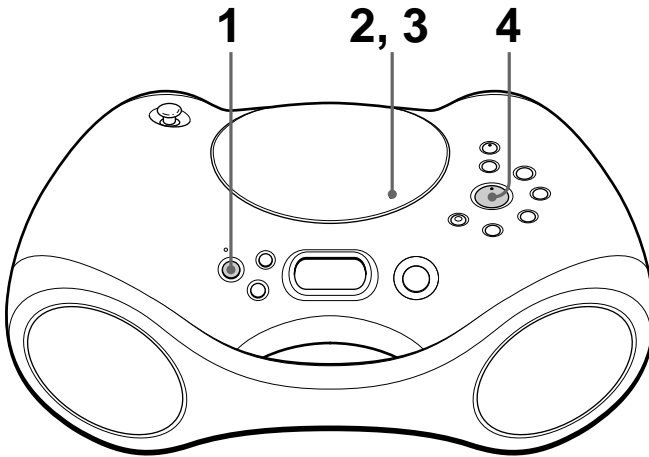

Connect the supplied AC power adaptor (see page 18).

1

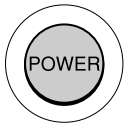

Press POWER to turn on the player.

2

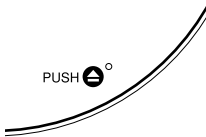

Press  PUSH down to open the CD compartment and place the CD on the CD compartment until it clicks into place.

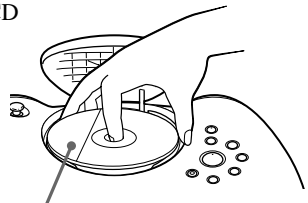

With the label side up

3

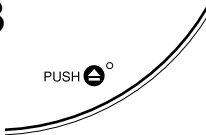

Close the lid of the CD compartment.

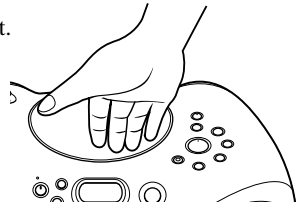

4



Press ►||.

The player plays all the tracks once.

To play a CD with MP3 files, see page 6.

Display

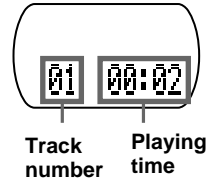

Use these buttons for additional operations

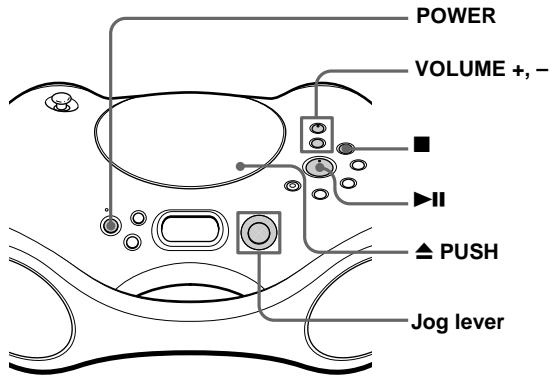
**Tip**

Playback starts from the track you last stopped playing (Resume play). During stop, the track number to be played are displayed.

To cancel the resume play to start play from the beginning of the first track, press ■ in stop mode.

To	Do this
adjust the volume	Press VOLUME +*, -.
stop playback	Press ■.
pause playback	Press ► *. Press the button again to resume play after pause.
go to the next track	Push jog lever toward ►►.
go back to the previous track	Push jog lever toward ◀◀.
remove the CD**	Press ▲ PUSH.
turn on/off the player	Press POWER.

* The button has a tactile dot.

**Once you open the CD compartment, the track to start play will change to the beginning of the first track.

continued

Playing a CD with MP3 files

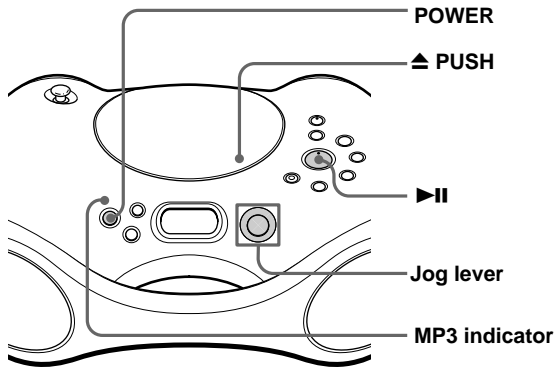

Note

Before playing a file, this player reads all file and folder information on the CD. Depending on the file structure, it may take more than a minute to read them. During this time, "Reading" is displayed.

Tip

You can use the buttons mentioned in the table on page 5 for additional operations in the same way as when playing an audio CD.

- 1 Press **POWER** to turn on the player.
- 2 Press **▲ PUSH** to open the CD compartment and place the CD on the CD compartment (see page 4) .
- 3 Close the lid of the CD compartment.
- 4 Press **▶||**.
The player plays all MP3 files on the CD.
When you play a CD with MP3 files, the MP3 indicator lights up.

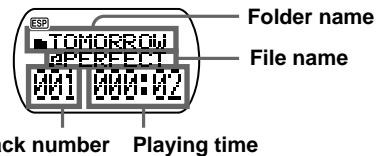

To select a folder

Push the jog lever toward **FLDR +** to go forward and **FLDR -** to go backward.

To select a file

Push the jog lever toward **▶▶** to go forward and **◀◀** to go backward.

Notes

- A folder that does not include an MP3 file is skipped.
- Maximum number of folders: 255
Maximum number of files: 255
- Folder names and file names can be displayed with up to 64 characters.
- The characters A - Z, a - z, 0 - 9, and _ can be displayed on this player. Other characters are displayed as “*”.
- This player conforms to Version 1.1 of the ID3 tag format. If the file has the ID3 tag information, “song title”, “artist name” and “album name” can be displayed.

Example of folder structure and playing order

The playing order of the folders and files is as follows:

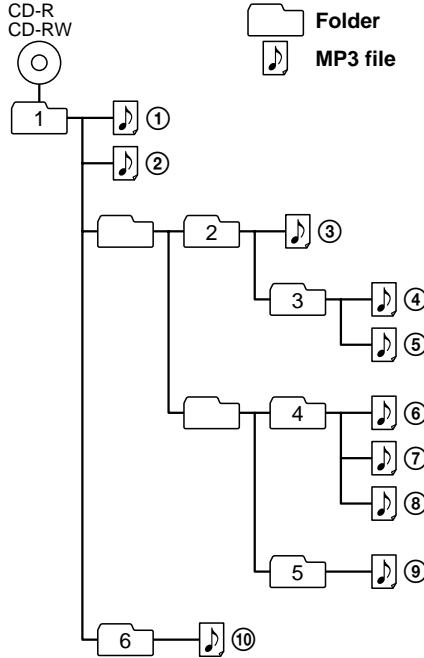

About CD-Rs/CD-RWs and MP3 files

This player can play CD-Rs/CD-RWs recorded in the CD-DA format* and MP3 files recorded in the CD-ROM format, but playback capability may vary depending on the quality of the disc and the condition of the recording device.

* CD-DA is the abbreviation for Compact Disc Digital Audio. It is a recording standard used for Audio CDs.

Listening to the radio

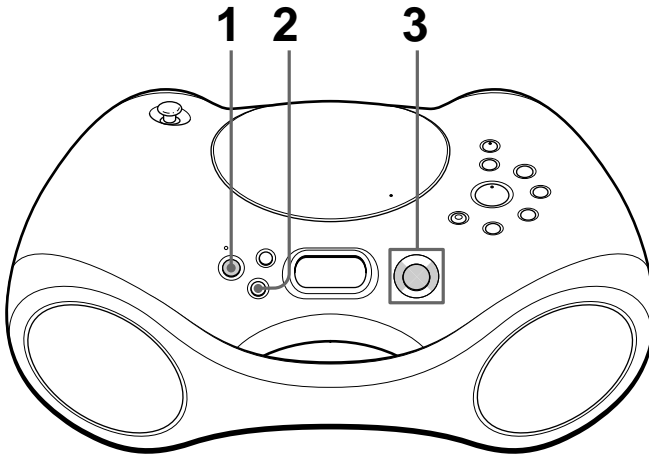

Connect the supplied AC power adaptor (see page 18).

1

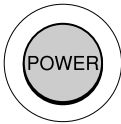

Press POWER to turn on the player.

2



Press BAND•AUTO PRESET until the band you want appears in the display.

Display

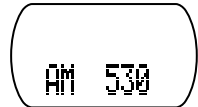

3

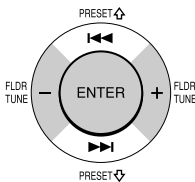

Push the jog lever toward TUNE + or TUNE - and hold it until the frequency digits begin to change in the display.

The player automatically scans the radio frequencies and stops when it finds a clear station.

If you can't tune in a station, push the jog lever toward TUNE + or TUNE - repeatedly to change the frequency step by step.

Indicates an FM stereo broadcast

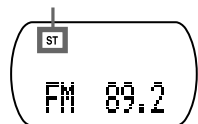

Use these buttons for additional operations

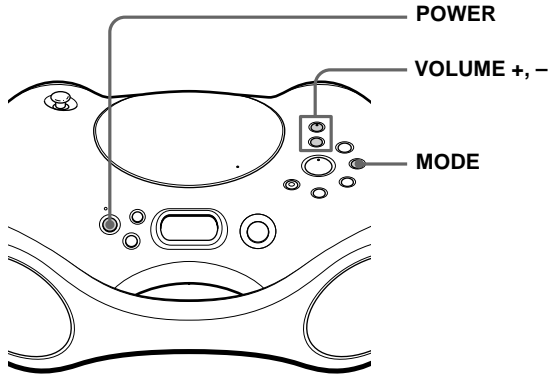

Tip

If the FM broadcast is noisy, press MODE until “Mono” appears in the display and radio will play in monaural.

To	Press
adjust the volume	VOLUME +*, -
turn on/off the radio	POWER

*VOLUME + has a tactile dot.

To improve broadcast reception

Reorient the antenna for FM. Reorient the player itself for AM.

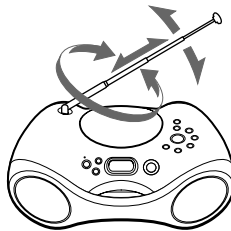

for FM

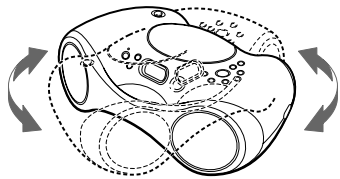

for AM

Using the display

You can check information about the CD using the display.

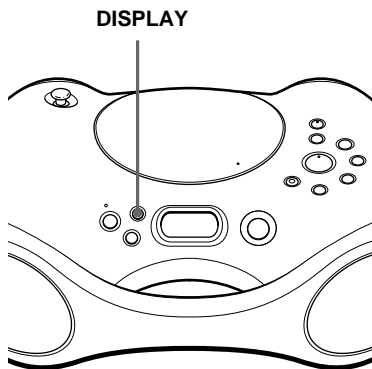

ring time

track number

Locating a specific point in a track

You can find a specific point in a track while playing a CD.

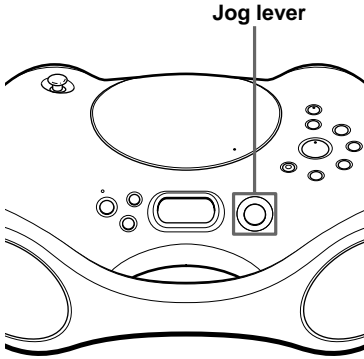

To locate	Do this
a point while listening to the sound	While playing, push the jog lever toward ►►► (forward) or ◄◄◄ (backward) and hold it until you find the point
a point while observing the display	In pause, push the jog lever toward ►►► (forward) or ◄◄◄ (backward) and hold it until you find the point

Note

When you find a specific point in a track while playing MP3 files, the sound may not be heard for a few seconds.

Playing tracks repeatedly (Repeat Play)

You can play tracks repeatedly in normal, shuffle or program play modes.

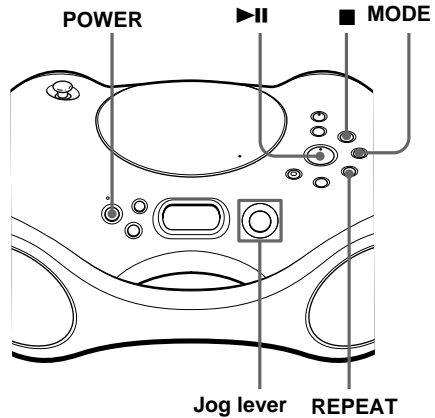

- 1 Press **POWER** to turn on the player.
- 2 Press **MODE**.
“CD” appears in the display.
- 3 Proceed as follows.

To repeat	Do this
a single track	<ol style="list-style-type: none"> 1 Press REPEAT until “REP 1” appears. 2 Select the track by pushing the jog lever toward ►►► or ◄◄◄, then press ►►►.
all tracks on the CD	<ol style="list-style-type: none"> 1 Press REPEAT until “REP ALL” appears. 2 Press ►►►.
a selected folder (MP3 CD only)	<ol style="list-style-type: none"> 1 Press REPEAT until “REP [FLDR]” appears. 2 Select the folder by pushing the jog lever toward FLDR + or FLDR -, then press ►►►.
tracks in random order	<ol style="list-style-type: none"> 1 Start Shuffle Play (see page 12). 2 Press REPEAT until “REP” appears.

Playing tracks in random order (Shuffle Play)

You can play tracks in random order.

▶|| ■ MODE

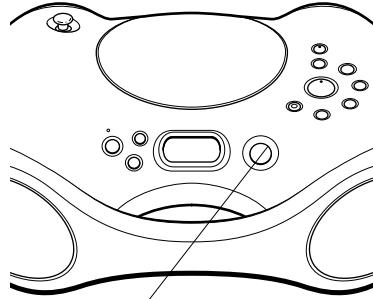

- 1** Press **POWER** to turn on the player.
- 2** Press **■**.
“CD” appears in the display.
- 3** Press **MODE** until “SHUF” appears in the display.
- 4** Press **▶||** to start Shuffle Play.

To cancel Shuffle Play

Stop playing first. Then press **MODE** until “SHUF” disappears from the display.

When playing MP3 files

The player plays all files (up to 255 files) on a CD in random order.

Tips

- During Shuffle Play, you cannot select the previous track by pushing the jog lever toward **▶▶|**.
- The resume function doesn't work during Shuffle Play.

Creating your own program (Program Play)

You can arrange the playing order of up to 20 tracks or files on a CD. When playing an MP3 files, you can also program up to 20 folders (Program Folder Play).

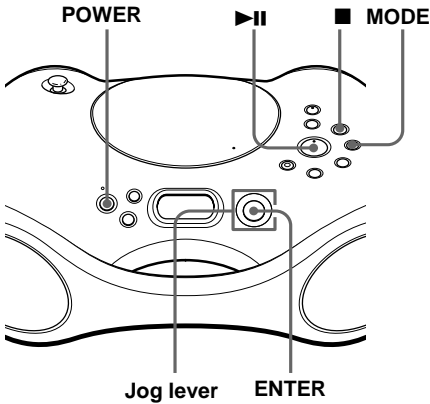

- 1** Press POWER to turn on the player.
- 2** Press ■. "CD" appears in the display.
- 3** Press MODE until "PGM" appears in the display.
When you select Program Folder Play (MP3 CD only), press MODE until "PGM FLDR" appears in the display.

- 4** Push the jog lever toward **◀◀** or **▶▶** then press ENTER for the tracks or files* you want to program in the order you want.

*folders for Program Folder Play.

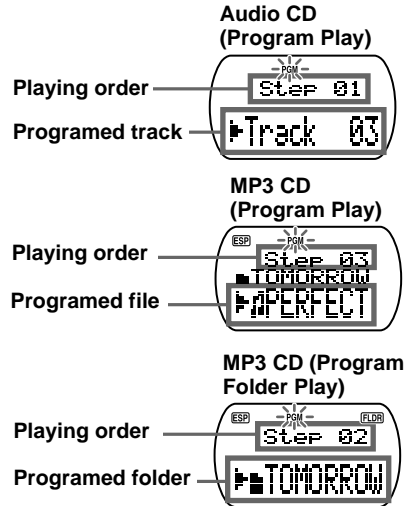

- 5** Press **▶▶** to start Program Play.

To cancel Program Play
Stop playing first. Then press MODE until "PGM" disappears from the display.

To check the order of tracks before play
Press ENTER.

Every time you press the button, the track or folder number appears in the programmed order.

To change the current program
Press ■ once if the CD is stopped and twice if the CD is playing. The current program will be erased. Then create a new program following the programming procedure.

continued

Creating your own program (Program Play) (continued)

Tips

- You can play the same program again, since the program is saved until you open the CD compartment.
- The resume function doesn't work during Program Play.

Preventing sound from skipping (ESP)

The ESP (Electronic Shock Protection) function prevents the sound from skipping by using a buffer memory that stores music data for about 10 seconds.

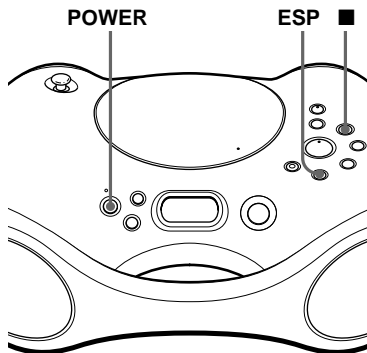

-
- 1** Press **POWER** to turn on the player.

 - 2** Press **■**.
“CD” appears in the display.

 - 3** Press **ESP**.
The ESP indication appears in the display.
-

To cancel the ESP function
Press **ESP** again.

Notes

- Playing may stop when the player gets a strong shock even with the ESP function on.
- You may hear a noise or sound skip:
 - when you listen to a dirty or scratched CD.
 - when you listen to an audio test CD.
 - when the player receives continuous shock.
- Sound may drop for a while if you press **ESP** during play.

Tips

- When an MP3 CD is playing, the ESP function is always activated due to a special character of MP3 files. For this reason, you cannot cancel the ESP function by pressing the **ESP** button.
- To enjoy the high quality sound of an audio CD, we recommend that you cancel the ESP function.

Presetting radio stations

You can store radio stations into the player's memory. You can preset up to 30 radio stations, 20 for FM and 10 for AM in any order.

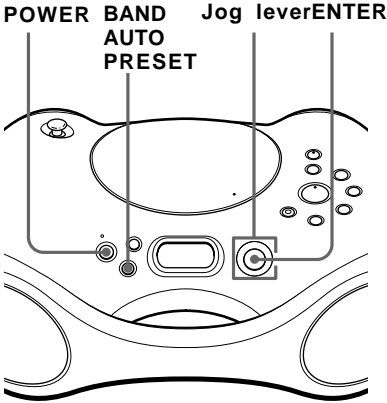

If a station cannot be preset automatically

You need to preset a station with a weak signal manually.

- 1 Press **POWER** to turn on the player.
- 2 Press **BAND•AUTO PRESET** to select the band.
- 3 Tune in a station you want.
- 4 Hold down **ENTER** for about 2 seconds.
- 5 Push the jog lever toward **PRESET** ↓ or **PRESET** ↑ until the preset number you want for the station on flashes.
- 6 Press **ENTER**.

The new station replaces the old one.

- 1 Press **POWER** to turn on the player.
- 2 Press **BAND•AUTO PRESET** to select the band.
- 3 Hold down **BAND•AUTO PRESET** until "Auto Preset" flashes in the display.
- 4 Press **ENTER**.
The stations are stored in memory from the lower frequencies to the higher ones.

Playing preset radio stations

Once you've preset the stations, use the jog lever to tune in your favorite stations.

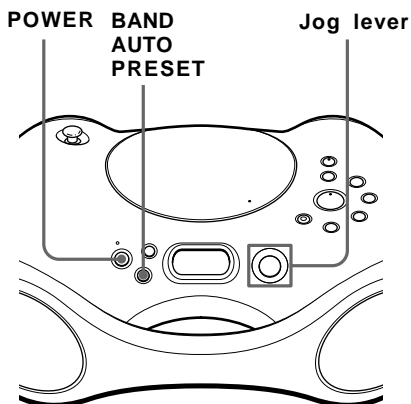

-
- 1** Press **POWER** to turn on the player.

 - 2** Press **BAND•AUTO PRESET** to select the band.

 - 3** Push the jog lever toward **PRESET ↓** or **PRESET ↑** to tune in the stored station.
-

Selecting the audio emphasis (MEGA BASS)

You can adjust the audio emphasis of the sound you are listening to.

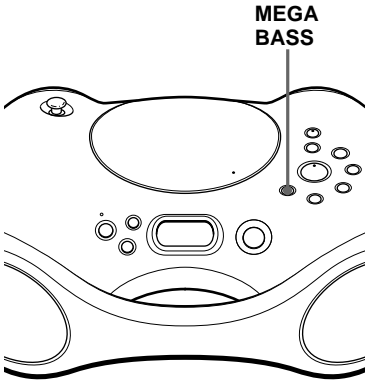

Reinforcing the bass sound

Press MEGA BASS to display “MEGA BASS On”.

To return to normal sound, press the button again to display “MEGA BASS Off”.

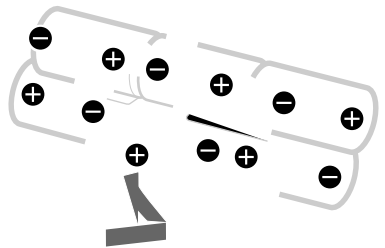

Polarity of the plug

Enjoying various pattern options on the display

Like a screen-saver on a PC, graphics can be displayed on you player. There are three different patterns.

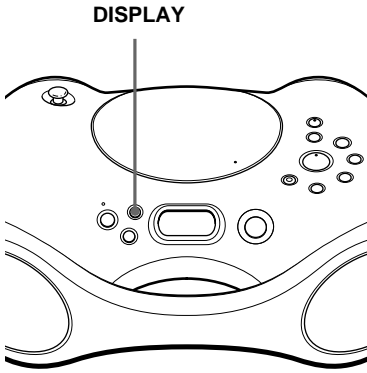

While the power is on, press DISPLAY for about 2 seconds.

“Graphics On” appears in the display and one of the graphic patterns will appear.

To return to the usual display
Press DISPLAY for about 2 seconds until
“Graphics Off” appears in the display.

Tip

While a graphic pattern is displayed, you can still operate the player as usual.

Precautions

On safety

- As the laser beam used in the CD player section is harmful to the eyes, do not attempt to disassemble the casing. Refer servicing to qualified personnel only.
- Should any solid object or liquid fall into the player, unplug the player, and have it checked by qualified personnel before operating it any further.
- Discs with non-standard shapes (e.g., heart, square, star) cannot be played on this player. Attempting to do so may damage the player. Do not use such discs.

On power sources

- For AC operation, use the supplied AC power adaptor; do not use any other type.
- The player is not disconnected from the AC power source (mains) as long as it is connected to the wall outlet, even if the player itself has been turned off.
- Unplug the player from the wall outlet when it is not to be used for an extended period of time.
- For battery operation, use six size D (R20) batteries.
- When the batteries are not to be used, remove them to avoid damage that can be caused by battery leakage or corrosion.
- The nameplate indicating operating voltage, power consumption, etc. is located at the bottom.

On placement

- Do not leave the player in a location near heat sources, or in a place subject to direct sunlight, excessive dust or mechanical shock.
- Do not place the player on an inclined or unstable place.
- Do not place anything within 10 mm of the side of the cabinet. The ventilation holes must be unobstructed for the player to operate properly and prolong the life of its components.

- If the player is left in a car parked in the sun, be sure to choose a location in the car where the player will not be subjected to the direct rays of the sun.
- Since a strong magnet is used for the speakers, keep personal credit cards using magnetic coding or spring-wound watches away from the player to prevent possible damage from the magnet.

Do not immerse in water

This product is not meant to be immersed in water or come in continuous contact with water.

- Before opening or shutting the CD compartment or battery compartment lid, be sure to wipe off water, dust or sand on the outside of the player.
- Water in the headphones jack may cause rusting. Cover the jack with the attached rubber cap when the headphones is not used.
- If the player is splashed with salt water, wipe clean with a damp cloth, then dry with a soft dry cloth. Do not wash under running water; do not use soap or detergent; do not dry with an electric hair dryer.
- The supplied AC power adaptor is not water resistant. To prevent shock hazard, avoid using the player near water during AC operation.

Troubleshooting

General

The power is not on.

- Connect the AC power adaptor to a wall outlet securely.
- Make sure the batteries are inserted correctly.

The power is not on, and “Low Battery” is displayed.

- Replace all the batteries with new ones if they are weak.

The power is not on, and “Battery Error” is displayed.

- Make sure the batteries are inserted correctly.

There is no audio.

- Make sure the function you want to use appears in the display window.
- Adjust the volume.
- Unplug the headphones when listening through speakers.

Noise is heard.

- Someone is using a portable telephone or other equipment that emits radio waves near the player. → Move the portable telephone, etc., away from the player.
-

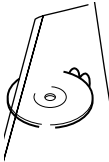

CD Player

“No disc” lights in the display even when a CD is in place.

- Insert the CD with the label surface up.
- The CD-R/CD-RW is blank.
- The CD-R/CD-RW was not finalized. Finalize the CD-R/CD-RW with the recording device.
- There is a problem with the quality of the CD-R/CD-RW, recording device, or application software.

The CD does not play.

- Make sure that the CD compartment is closed.
 - Place the CD with the label surface up.
 - Clean the CD.
 - Take out the CD and leave the CD compartment open for about an hour to dry moisture condensation.
 - Make sure “CD” appears in the display.
-

The sound drops out.

- Reduce the volume.
 - Clean the CD, or replace it if the CD is badly damaged.
 - Place the player in a location free from vibration.
 - The sound may drop out or noise may be heard when using poor quality CD-Rs/CD-RWs or if there is a problem with the recording device or application software.
-

“Not MP3” is displayed.

- You are trying to play a file that is not an MP3 file but has extension “mp3”. (page 25)
-

“Not MP3 (Layer-1, 2)” is displayed.

- You are trying to play an MPEG1 Audio Layer-1 or 2 file. You can only play MP3 (MPEG 1 Audio Layer-3) files on this player. (page 25)
-

Radio

The audio is weak or has poor quality.

- Replace all the batteries with new ones if they are weak.
 - Move the player away from the TV.
-

The picture of your TV becomes unstable.

- If you are listening to an FM program near the TV with an indoor antenna, move the player away from the TV.
-

After trying the above remedies, if you still have problems, unplug the AC power adaptor and remove all the batteries. After all the indications in the display disappear, plug the AC power adaptor and insert the batteries again. If the problem persists, please consult your nearest Sony dealer.

Maintenance

Cleaning the lens

If the lens becomes dirty, it may cause a skipping of sound during CD operation. Clean with a commercially available blower.

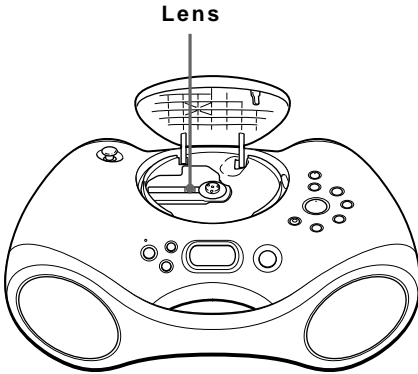

Cleaning the cabinet

Clean the cabinet, panel and controls with a soft cloth slightly moistened with a mild detergent solution. Do not use any type of abrasive pad, scouring powder, or solvent, such as alcohol or benzine.

Specifications

AUDIO POWER SPECIFICATIONS

POWER OUTPUT AND TOTAL HARMONIC DISTORTION

With 3.2-ohm loads, both channels driven from 150 - 10,000 Hz; rated 1.8 W per channel—minimum RMS power, with no more than 10 % total harmonic distortion in AC operation.

Other Specifications

CD player section

System

Compact disc digital audio system

Laser diode properties

Material: GaAlAs

Wave length: 780 nm

Emission duration: Continuous

Laser output: Less than 44.6 μ W

(This output is the value measured at a distance of about 200 mm from the objective lens surface on the optical pick-up block with 7 mm aperture.)

Spindle speed

200 r/min (rpm) to 500 r/min (rpm) (CLV)

Number of channels

2

Frequency response

20 - 20 000 Hz +1/-2 dB

Wow and flutter

Below measurable limit

Radio section

Frequency range

FM: 87.5 - 108 MHz

AM: 530 - 1 710 kHz

Antennas

FM: Telescopic antenna

AM: Built-in ferrite bar antenna

General

Speaker

Full range: 10 cm (4 in.) dia.,

3.2 Ω , cone type (2)

Outputs

Headphones jack (stereo minijack)

For 16 - 68 Ω impedance headphones

Power output

2.3 W + 2.3 W (at 3.2 Ω , 10 % harmonic distortion)

Power requirements

DC IN 9V jack accepts:

Supplied AC power adaptor for use with 120 V AC, 60 Hz

9 V DC, 6 size D (R20) batteries

Battery life

For CD playback:

Sony R20P: approx. 7.5 h

Sony alkaline LR20: approx. 14 h

Dimensions

Approx. 430 \times 172 \times 287.5 mm (w/h/d)

(17 \times 6 $\frac{7}{8}$ \times 11 $\frac{3}{8}$ inches) (incl. projecting parts)

Mass

Approx. 4.6 kg (7 lb. 11 oz) (incl. batteries)

Supplied accessories

AC power adaptor (1)

Design and specifications are subject to change without notice.

Optional accessories

Sony MDR headphones series

THE USABLE NUMBER OF FOLDERS/FILES

- Maximum folder number: 255
- Maximum file number: 255

SETTINGS FOR COMPRESSION SOFTWARE AND WRITING SOFTWARE

- To compress a source for an MP3 file, we recommend setting the transfer bit rate of the compression software to “44.1 kHz”, “128kbps”, and “Constant Bit Rate”.
- To record up to the maximum capacity, set to the “halting of writing”.
- To record at one time up to the maximum capacity on media that has nothing recorded it, set to “Disc at Once”.

NOTES FOR SAVING FILES ON THE MEDIA

When the disc is inserted, the player reads all the files on that disc. If there are many folders or non-MP3 files on the disc, it may take a long time for play to begin or for the next MP3 file to start play.

Do not save unnecessary folders or files other than MP3 ones in the disc to be used for MP3 listening.

We recommend that you do not save other types files or unnecessary folders on a disc that has MP3 files.

Index

A

Audio emphasis 17

B

Batteries
for player 18

C

CD player 4
Choosing power sources 18
Cleaning
cabinet 23
lens 23
Connecting AC power adaptor
18
Creating your own program 13

D

Display 10

E, F, G, H

ESP 14

I, J, K

ID3 tag 10, 25
Improving broadcast reception
9

L

Listening to the radio 8
Locating a specific point 11

M, N, O

Maintenance 23
MEGA BASS 17
MP3
about MP3 25
display 10
playing order 7

P, Q

Pattern options 19
Playing
a CD 4
preset radio stations 16
tracks in random order 12
tracks repeatedly 11
Power sources 18
Precautions 20
Presetting radio stations 15
Program Play 13

R

Radio stations
playing 16
presetting 15
Repeat Play 11

S

Selecting
audio emphasis 17
tracks 5
Setting up 18
Shuffle Play 12
Specifications 24

T

Troubleshooting 21

U, V, W, X, Y, Z

Using the display 10

For customers in the USA

Please register this product on line at **<http://www.sony.com/productregistration>**.

Proper registration will enable us to send you periodic mailings about new products, services and other important announcements. Registering your product will also allow us to contact you in the unlikely event that the product needs adjustment or modification. Thank you.